

RO TOMAL GRILL

ROTATING ELECTRIC FLATBREAD GRILL

TOP VIEW

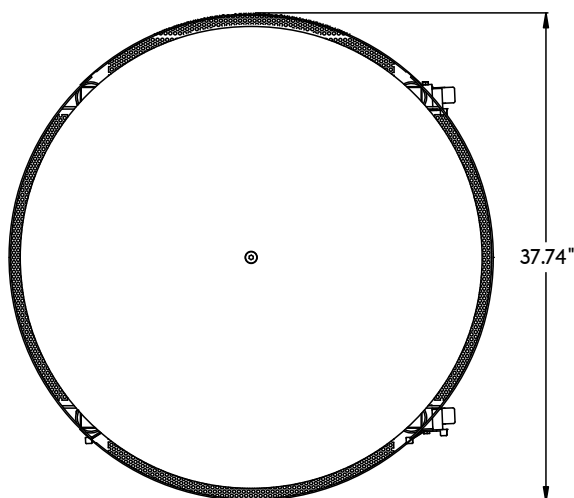

SIDE VIEW

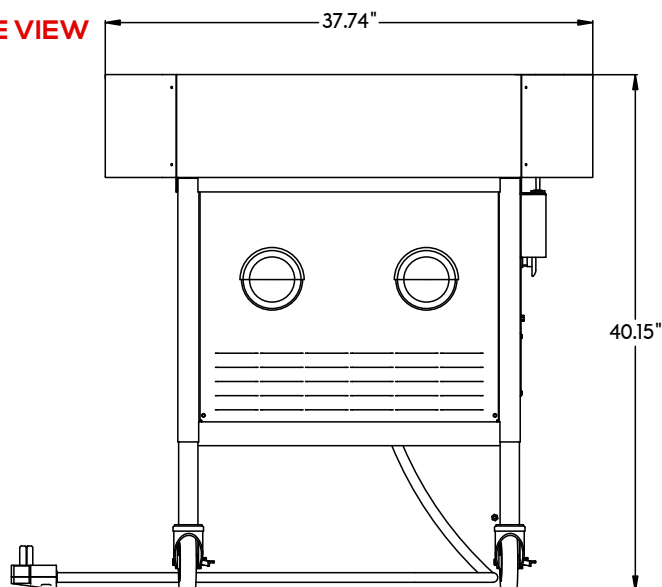

- 

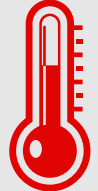

EVEN HEAT DISTRIBUTION
- 

SINGLE PERSON OPERATION
- 

QUALITY
- 

TEMPERATURE CONTROLLED PLATES
- 

NON-STICK

VOLTS	220V/240V	WEIGHT	300LBS.
AMPS	42	DIMENSIONS	37.74" L X 37.74" W X 40.15" H
CYCLES	60HZ	ELECTRICAL	 PLUG: NEMA 10-50P (250V~)  RECEPTACLE: NEMA 10-50R (250V~)
PHASE	SINGLE	POWER	10000 WATTS



BE&SCO EQUIPMENT IS SOLELY INTENDED FOR USE IN A COMMERCIAL FACILITY.

REVISED: 01/29/2021