

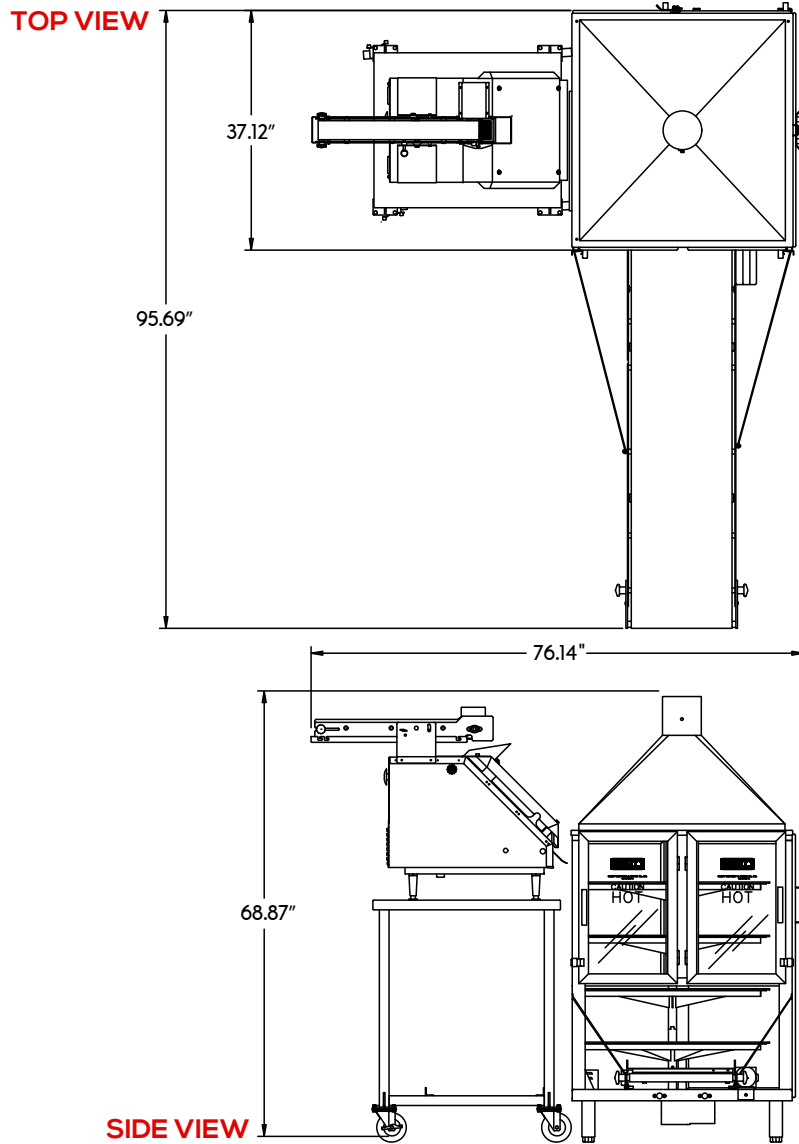



BETAMAX COMBO - RIGHT EXIT - 60" AUTOMATIC FLATBREAD PRESS, STAND, OVEN & DTL



- 

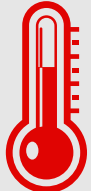





DIAMETER FROM 4" TO 12"
- 

HIGH PRODUCTION
- 

TEMPERATURE CONTROLLED PLATES
- 

AUTOMATIC
- 

CALIBRATED TO YOUR RECIPE

PRESS VOLTS	220V/240V	OVEN VOLTS	120V/240V
PRESS AMPS	23.4	OVEN AMPS	3
PRESS CYCLES	60HZ	OVEN POWER (GAS)	100000 BTU/HR
PRESS POWER	5600 WATTS	OVEN ELECTRICAL (120V)	 PLUG: NEMA 5-20P (125V~)  RECEPTACLE: NEMA 5-20R (125V~)
PRESS ELECTRICAL	 PLUG: NEMA 10-50P (250V~)  RECEPTACLE: NEMA 10-50R (250V~)	OVEN ELECTRICAL (240V)	 PLUG: NEMA 6-20P (250V~)  RECEPTACLE: NEMA 6-20R (250V~)
COMBO DIMENSIONS	95.69" L X 76.1" W X 68.87" H	COMBO WEIGHT	1030LBS.



*Certifications Applicable to Press and Oven Only. Certifications Not Applicable to Stands.

**Production may vary due to the operator experience, diameter and thickness of product.

BESCO EQUIPMENT IS SOLELY INTENDED FOR USE IN A COMMERCIAL FACILITY.



REVISED: 03/18/2021