

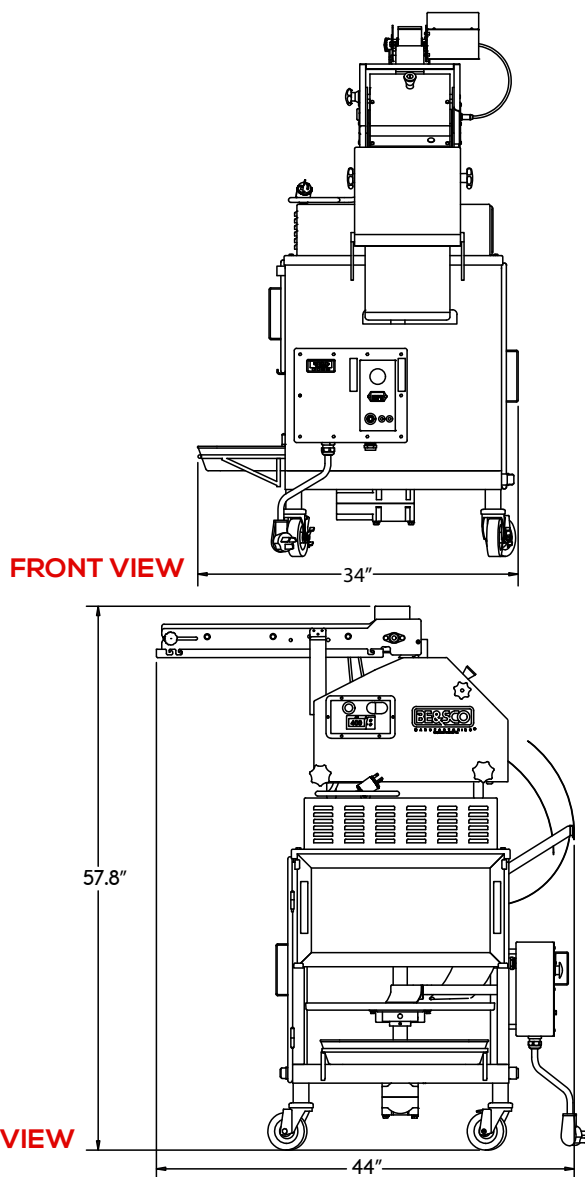

BETA 450 ELECTRIC COMBO

AUTOMATIC FLATBREAD PRESS, OVEN & DTL



- 





DIAMETER FROM
4" TO 7"
- 

450/HR.
HIGH
PRODUCTION
- 

SINGLE PERSON
OPERATION
- 

CALIBRATED TO
YOUR RECIPE
- 

AUTOMATIC

PRESS VOLTS	120V	OVEN VOLTS	240V
PRESS AMPS	15	OVEN AMPS	20
PRESS POWER	1800 WATTS	OVEN POWER	4800 WATTS
PRESS ELECTRICAL	 PLUG: NEMA 5-20P (125V~)  RECEPTACLE: NEMA 5-20R (125V~)	OVEN ELECTRICAL	 PLUG: NEMA 10-50P (250V~)  RECEPTACLE: NEMA 10-50R (250V~)
COMBO DIMENSIONS	44" L X 34" W X 57.8" H	COMBO WEIGHT	320LBS.

***You will need 240V to fully utilize the capabilities of the Beta 450 Electric Combo. Less than 220V requires installation of Buck and Boost.**

****Production may vary due to the operator experience, diameter and thickness of product.**

BE&SCO EQUIPMENT IS SOLELY INTENDED FOR USE IN A COMMERCIAL FACILITY.

REVISED: 08/10/2021

